

ASSEMBLY INSTRUCTIONS

Option 1: Canopy Mounted Driver

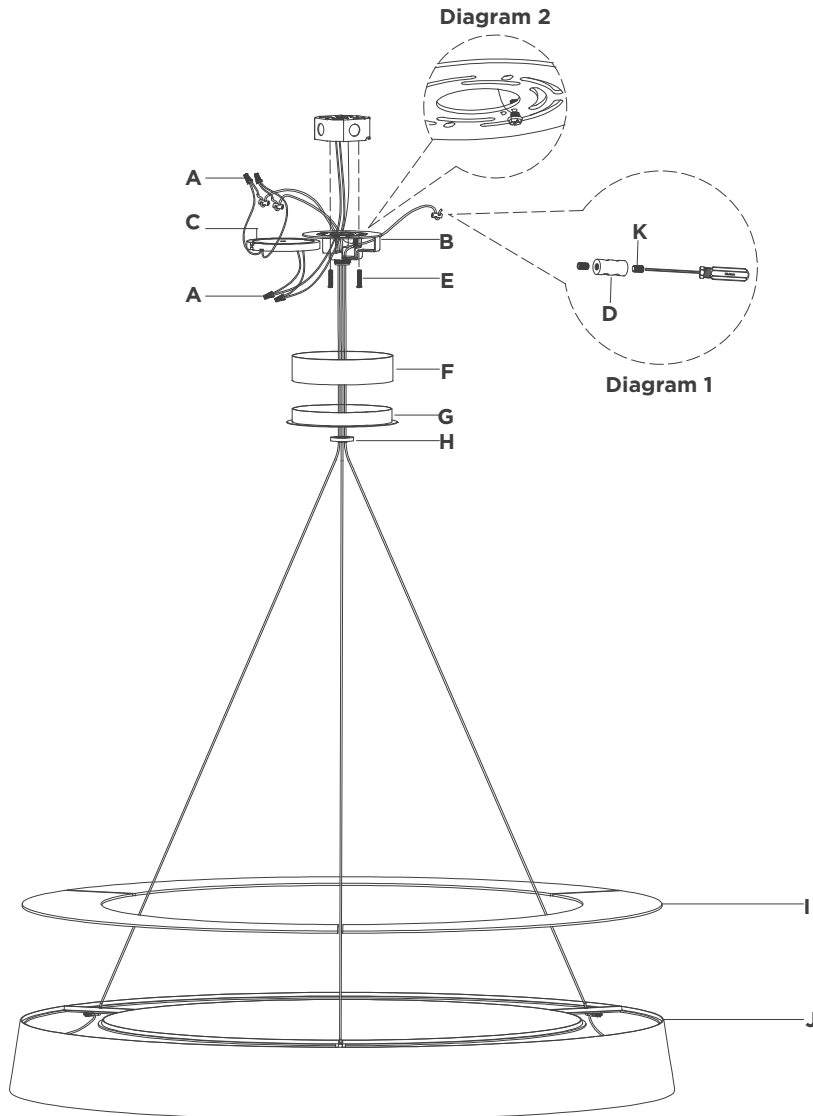

Neptune 48" Uplight Ring Chandelier

Item # BBL5098

WE RECOMMEND INSTALLATION OF THIS LIGHTING FIXTURE BE DONE BY A LICENSED ELECTRICIAN.

WARNING*SWITCH OFF THE MAIN ELECTRICAL SUPPLY FROM THE MAIN FUSE BOX/CIRCUIT BREAKER BEFORE INSTALLATION.**

INSPECT ITEM CAREFULLY BEFORE ATTEMPTING TO INSTALL.

IF THERE IS ANY DAMAGE OR OBVIOUS DEFECT. DO NOT INSTALL.

ITEM MAY NOT BE RETURNED ONCE IT HAS BEEN INSTALLED.

NOTE: CAREFULLY UNPACK EACH PIECE IN TOP LAYER OF PACKING PRIOR TO REMOVING. RETAIN ALL PACKING MATERIAL UNTIL INSPECTION AND INSTALLATION ARE FINAL.

1. Carefully remove all parts from the box. Place on a clean, soft surface.
2. Remove collar ring (H) from tall mounting plate (B) by unscrewing.
3. Install tall mounting plate (B) to the junction box and secure with mounting screws (E).
NOTE: It is recommended to have a helper assist in supporting the fixture for steps 4-5.
4. Feed hanging cables through collar ring (H), canopy (G) and driver housing (F), then insert through the middle hole of mounting plate bracket.
5. Install cable locks (D) to end of hanging cables. Insert hanging cable through other end of locks and tighten ends (K) with screwdriver to secure (see diagram 1).
6. Adjust hanging cables to desired height and level fixture.
NOTE: Double check height and ensure fixture is level before moving to next step.
7. Cut excess wires, being sure to leave enough to reach the junction box. Separate fixture wires (marked "+" & "-") and strip insulation on each 5/8".
8. Connect driver (C) output neutral wire (black) to the fixture neutral wire (marked "-") using wire nut (A).
9. Connect driver (C) output hot wire (red) to the fixture hot wire (marked "+") using wire nut (A).

CAUTION: Do not reverse the hot and neutral connections.

ASSEMBLY INSTRUCTIONS

Option 1: Canopy Mounted Driver

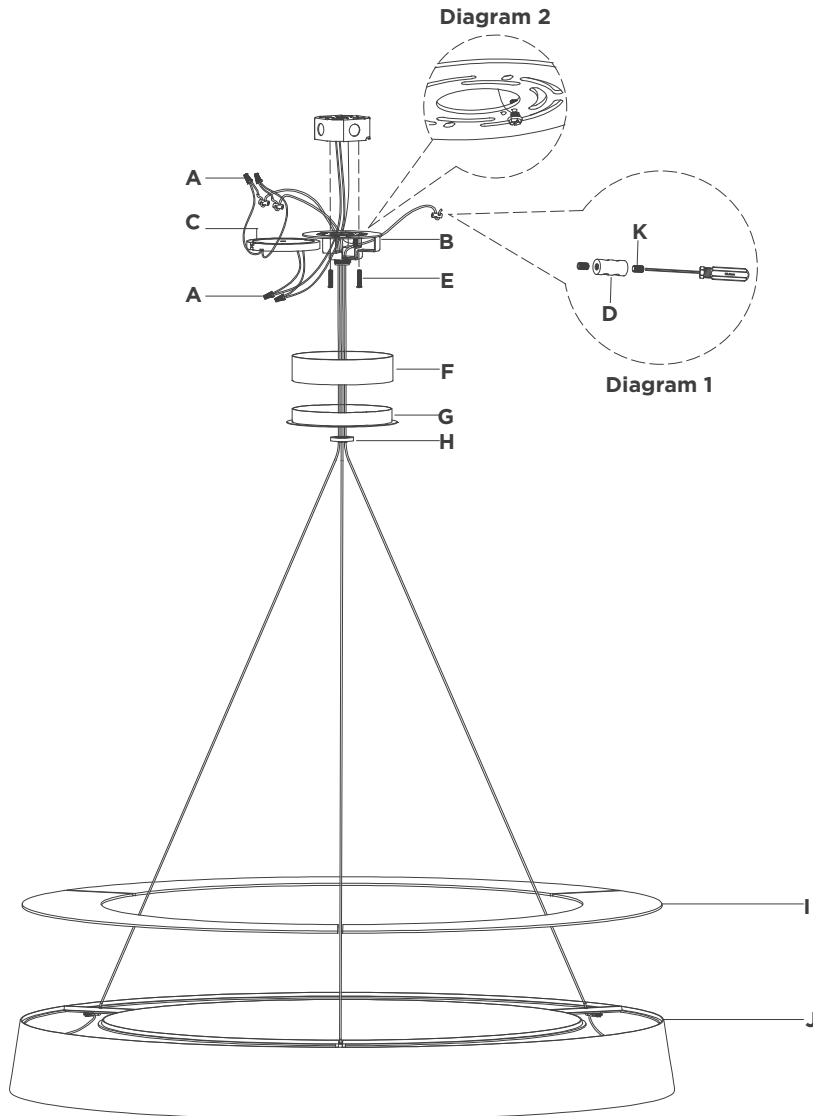

Neptune 48" Uplight Ring Chandelier

Item # BBL5098

WE RECOMMEND INSTALLATION OF THIS LIGHTING FIXTURE BE DONE BY A LICENSED ELECTRICIAN.

WARNING*SWITCH OFF THE MAIN ELECTRICAL SUPPLY FROM THE MAIN FUSE BOX/CIRCUIT BREAKER BEFORE INSTALLATION.**

INSPECT ITEM CAREFULLY BEFORE ATTEMPTING TO INSTALL.

IF THERE IS ANY DAMAGE OR OBVIOUS DEFECT. DO NOT INSTALL.

ITEM MAY NOT BE RETURNED ONCE IT HAS BEEN INSTALLED.

NOTE: CAREFULLY UNPACK EACH PIECE IN TOP LAYER OF PACKING PRIOR TO REMOVING. RETAIN ALL PACKING MATERIAL UNTIL INSPECTION AND INSTALLATION ARE FINAL.

10. Connect supply ground wire (usually green or bare copper) around the green grounding screw (see diagram 2). Tighten.
NOTE: It is imperative that the fixture is grounded.
11. Connect driver (C) input neutral wire (white) to the supply neutral wire (usually white) using wire nut (A).
12. Connect driver (C) input hot wire (black) to the supply hot wire (usually black) using wire nut (A).
CAUTION: Do not reverse the hot and neutral connections.
13. Make sure all wire connections are tight, then carefully tuck into the junction box.
14. Insert driver (C) into the center of mounting plate bracket (B).
15. Install driver housing (F) and canopy (G) to tall mounting plate (B) and secure with collar ring (H).
16. Place diffusers (I) on top of fixture body (J).
17. Installation is complete.

*** Clean with a dry, soft cloth only. Do not use harsh abrasives or chemical agents.

ASSEMBLY INSTRUCTIONS

Option 2: Ceiling Mounted Driver

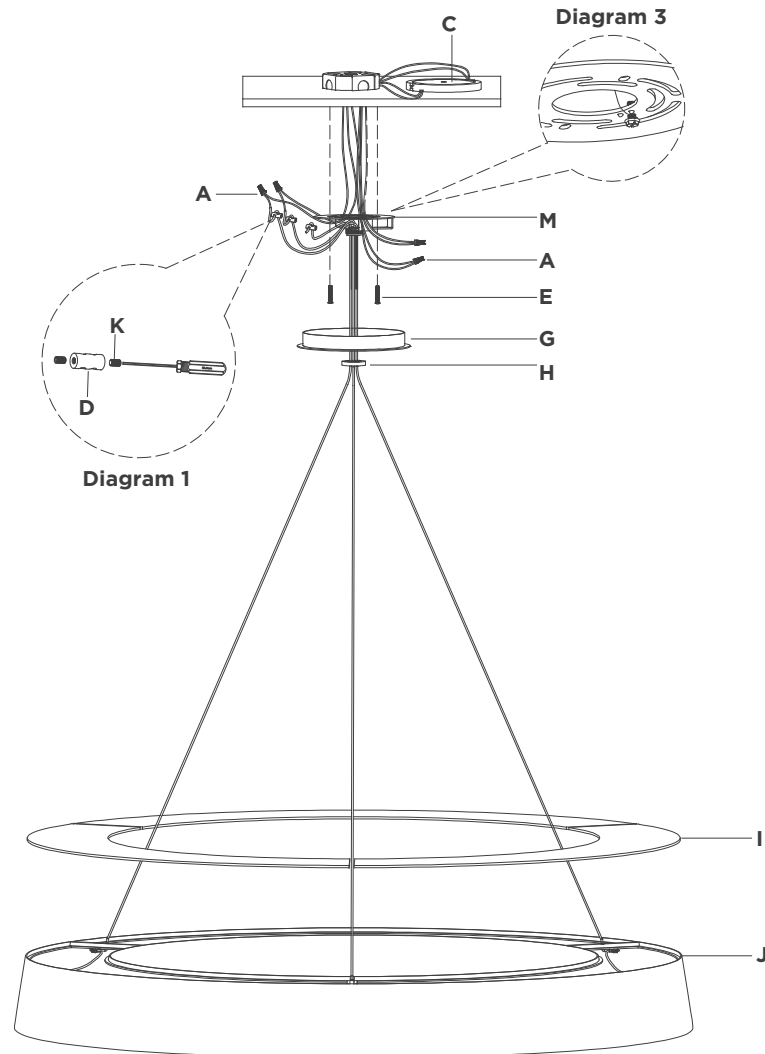

Neptune 48" Uplight Ring Chandelier

Item # BBL5098

WE RECOMMEND INSTALLATION OF THIS LIGHTING FIXTURE BE DONE BY A LICENSED ELECTRICIAN.

WARNING*SWITCH OFF THE MAIN ELECTRICAL SUPPLY FROM THE MAIN FUSE BOX/CIRCUIT BREAKER BEFORE INSTALLATION.**

INSPECT ITEM CAREFULLY BEFORE ATTEMPTING TO INSTALL.

IF THERE IS ANY DAMAGE OR OBVIOUS DEFECT. DO NOT INSTALL.

ITEM MAY NOT BE RETURNED ONCE IT HAS BEEN INSTALLED.

NOTE: CAREFULLY UNPACK EACH PIECE IN TOP LAYER OF PACKING PRIOR TO REMOVING. RETAIN ALL PACKING MATERIAL UNTIL INSPECTION AND INSTALLATION ARE FINAL.

1. Carefully remove all parts from the box. Place on a clean, soft surface.
2. Place driver (C) into ceiling and route all wires through one of the knockouts in the junction box.
3. Remove collar ring (H) from tall mounting plate (B) by unscrewing.
NOTE: Driver housing (F) and tall mounting plate (B) will not be used for ceiling mounted assembly. Keep part and store for future use.
4. Install short mounting plate (M) to the junction box and secure with mounting screws (E).
NOTE: It is recommended to have a helper assist in supporting the fixture for steps 5-6.
5. Feed hanging cables through collar ring (H) and canopy (G), then insert through the middle hole of mounting plate bracket.
6. Install cable locks (D) to end of hanging cables. Insert hanging cable through other end of locks and tighten ends (K) with screwdriver to secure (see diagram 1).
7. Adjust hanging cables to desired height and level fixture.
NOTE: Double check height and ensure fixture is level before moving to next step.
8. Cut excess wires, being sure to leave enough to reach the junction box. Separate fixture wires (marked "+" & "-") and strip insulation on each 5/8".
9. Connect driver (C) output neutral wire (black) to the fixture neutral wire (marked "-") using wire nut (A).

ASSEMBLY INSTRUCTIONS

Option 2: Ceiling Mounted Driver

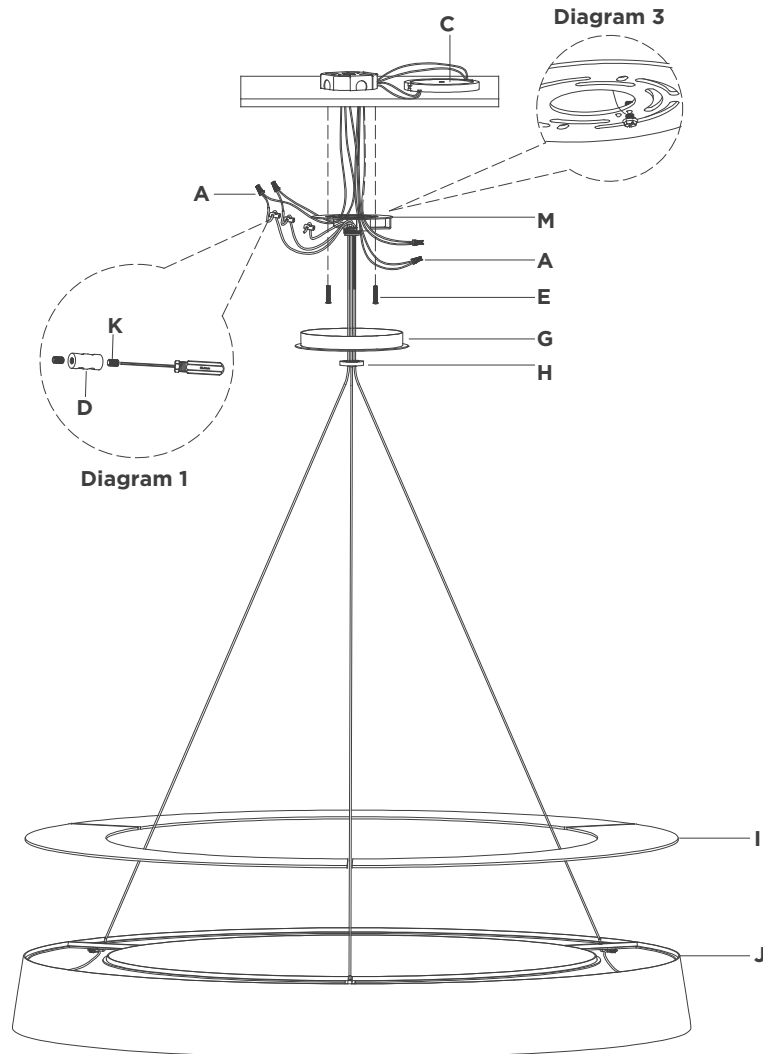

Neptune 48" Uplight Ring Chandelier

Item # BBL5098

WE RECOMMEND INSTALLATION OF THIS LIGHTING FIXTURE BE DONE BY A LICENSED ELECTRICIAN.

WARNING*SWITCH OFF THE MAIN ELECTRICAL SUPPLY FROM THE MAIN FUSE BOX/CIRCUIT BREAKER BEFORE INSTALLATION.**

INSPECT ITEM CAREFULLY BEFORE ATTEMPTING TO INSTALL.

IF THERE IS ANY DAMAGE OR OBVIOUS DEFECT. DO NOT INSTALL.

ITEM MAY NOT BE RETURNED ONCE IT HAS BEEN INSTALLED.

NOTE: CAREFULLY UNPACK EACH PIECE IN TOP LAYER OF PACKING PRIOR TO REMOVING. RETAIN ALL PACKING MATERIAL UNTIL INSPECTION AND INSTALLATION ARE FINAL.

10. Connect driver **(C)** output hot wire (red) to the fixture hot wire (marked "+") using wire nut **(A)**.
CAUTION: Do not reverse the hot and neutral connections.
11. Connect supply ground wire (usually green or bare copper) around the green grounding screw (see diagram 3). Tighten.
NOTE: It is imperative that the fixture is grounded.
12. Connect driver **(C)** input neutral wire (white) to the supply neutral wire (usually white) using wire nut **(A)**.
13. Connect driver **(C)** input hot wire (black) to the supply hot wire (usually black) using wire nut **(A)**.
CAUTION: Do not reverse the hot and neutral connections.
14. Make sure all wire connections are tight, then carefully tuck into the junction box.
15. Install canopy **(G)** to mounting plate **(L)** and secure with collar ring **(H)**.
16. Place diffusers **(I)** on top of fixture body **(J)**.
17. Installation is complete.

*** Clean with a dry, soft cloth only. Do not use harsh abrasives or chemical agents.