

TOB5156

ASSEMBLY & INSTALLATION GUIDE

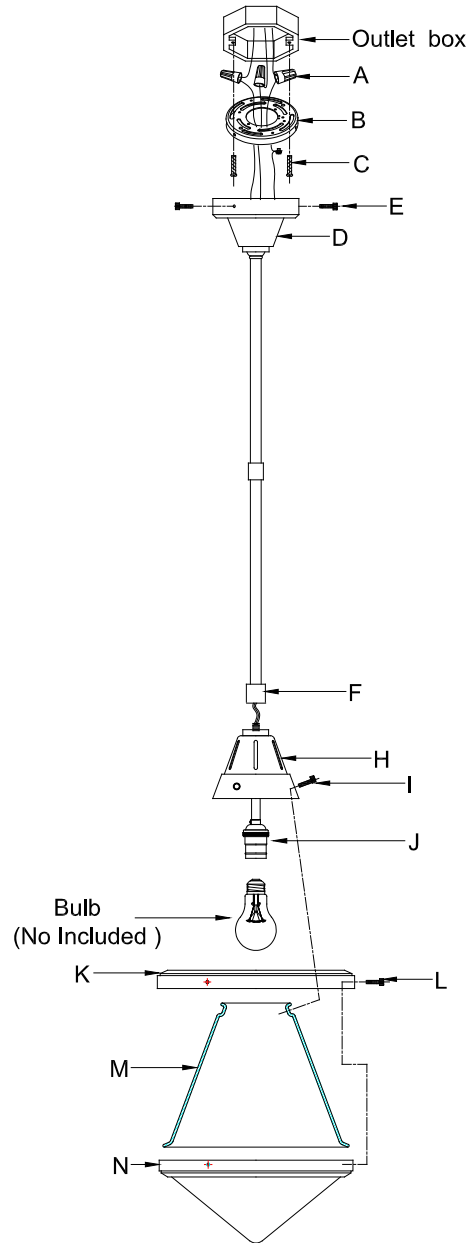

WE RECOMMEND INSTALLATION OF THIS LIGHTING FIXTURE BE DONE BY A LICENSED ELECTRICIAN.

WARNING * SWITCH OFF THE MAIN ELECTRICAL SUPPLY FROM THE MAIN FUSE BOX/CIRCUIT BREAKER BEFORE INSTALLATION.**

INSPECT ITEM CAREFULLY BEFORE ATTEMPTING TO INSTALL. IF THERE IS ANY DAMAGE OR OBVIOUS DEFECT, DO NOT INSTALL.

ITEM MAY NOT BE RETURNED ONCE IT HAS BEEN INSTALLED.

1. Remove all parts carefully from the carton.
2. Remove mounting plate (B) from the canopy (D) by unscrewing screws (E).
3. Attach mounting plate (B) to outlet box using mounting plate screws(C).
4. Attach the ground wire from the fixture to the ground wire from the building using the provided wire nut (A).
If you house has no bare wire (ground) attach this wire to the green grounding screw inside the outlet box.
5. IT IS IMPERATIVE THAT THIS FIXTURE BE GROUNDED.
6. Attach the common wire (ribbed, no words) from the fixture to the white wire from the building using the provided wire nut (A). Attach the hot wire (smooth, with words) from the fixture to the black wire from the building with the provided wire nut (A).
7. IT IS IMPERATIVE THAT YOU NOT MIX THESE WIRES.
8. Attach canopy (D) back to mounting plate (B) and secure with screws (E).
9. Thread metal shade cup (H) to stem (F).
10. Insert lamp bulb (not included) into socket (J).
11. Tight ring (K) &bottom shade (N), Glass shade (M) tighten by screw (L).
12. Tighten Whole assembled shade to metal cap (H) with screw (I)
13. Restore power and enjoy your new pendant.